

COB-740



Fiber coupled LED Light Source

The COB series comprises high power LED light sources with peak wavelengths that range from UV to NIR. They are conceived as user friendly, compact and silent tools, being ideal for fluorescence, spectroscopy and general fiber illumination applications.

These light sources have been designed to obtain a high coupling efficiency to optical fiber through a selectable SMA/FC connector. In addition, they can be operated either in continuous (CW) or pulsed modes.



Characteristics

Electrical characteristics		
Power input (1)	Input Voltage	10 - 18 V
	Input Current	1 A max
	Connector type	DC female 2.1mm
Input signal for Pulsed mode	Input Voltage	0 - 5 V
	Input Current	5 mA typ.
	Connector type	SMA female

(1) AC/DC adapter is included with the source. Input 100-240V, 50-60Hz.

Optical characteristics	
Output connector	SMA 905/FC
Peak wavelength	740 nm
Spectral range FWHM	18 nm
Typical optical power output (2)	7.3 mW

Other characteristics	
Working Temperature	0 - 50 °C
Humidity	<80 % HR
Equipment Surface Temperature	40 °C
Stabilization time	25 min typ.
Size	10.5 x 11.5 x 8 cm
Weight	500 g

(2) Measured with an optical fiber (core diameter 600µm) and a Si photodiode (OPHIR™)

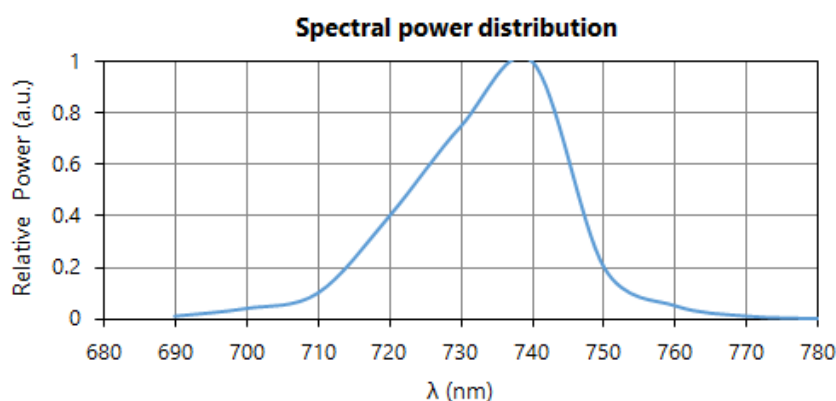

COB-740

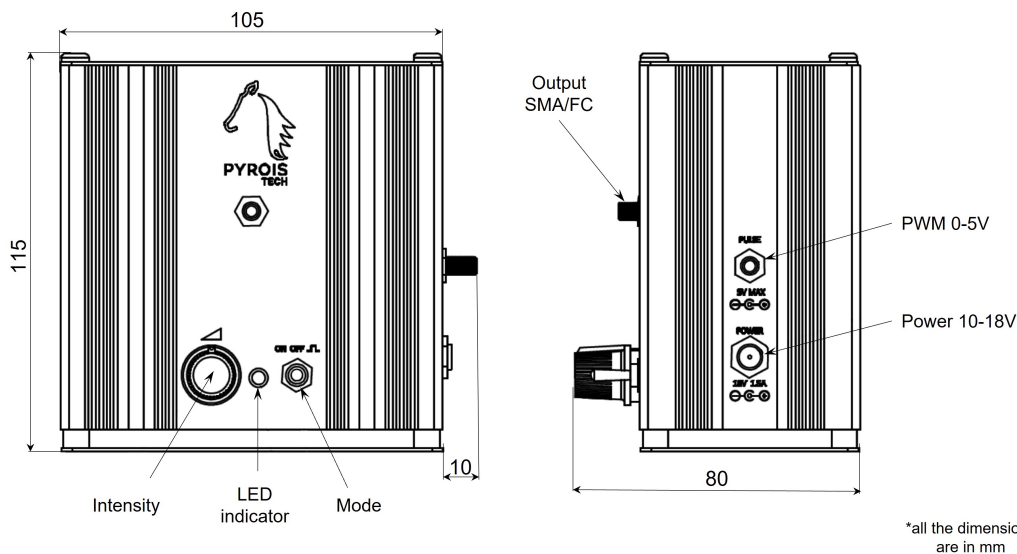

Operation Modes

Connect a proper power source (included with the light source) prior to operation.

The light source includes two controls on the front. The MODE switch on the right sets the operation mode between ON (left), OFF (centre) and PULSED (right).

The left knob controls the intensity in ON mode (switch on the left position). The intensity can be adjusted between 20% (fully counter-clockwise) and 100% (fully clockwise) of maximum intensity.

In PULSED mode (switch on the right position), the intensity can be controlled using a PWM (pulse width modulation) signal through the PWM input connector on the right side of the case. The intensity can be adjusted between 0% and 100% of maximum intensity changing the duty cycle of the PWM signal.

The PWM signal must vary between 0 and 5 V. Voltages out of this range can damage the PWM input and disable the PWM mode. A pulsed frequency of 500 Hz or lower is recommended to achieve the maximum resolution. However, higher frequencies, up to 100 kHz, can also be used.

Safety Notes

- Do not remove or modify any installed safety device on this equipment. Doing so will void your warranty and create an unsafe operating environment.
- Dangerous currents are present in this device. There are NO user serviceable parts inside.
- Only allow qualified personnel to service this unit.
- Inspect this unit and its power supply before using it for the first time.
- Do not use the unit if it is damaged in any way. Contact your dealer for repair or replacement information.
- During operation do not cover the source or obstruct the air flow for its refrigeration.
- Optical radiation can damage your eyes. Do not stare directly at the light source output.